



# GROWING UP GROWING



DISHING THE DIRT ON WHAT LIFE IS  
REALLY LIKE ON AN ILLINOIS FAMILY FARM

SEE ALL OUR STORIES AT [WATCHUSGROW.ORG](http://WATCHUSGROW.ORG)



There are a lot of incredible things you'll find on an Illinois farm. Farms have healthy animals, hardworking people, and amazing machines. But the most important thing you'll find on an Illinois farm? A family just like yours.

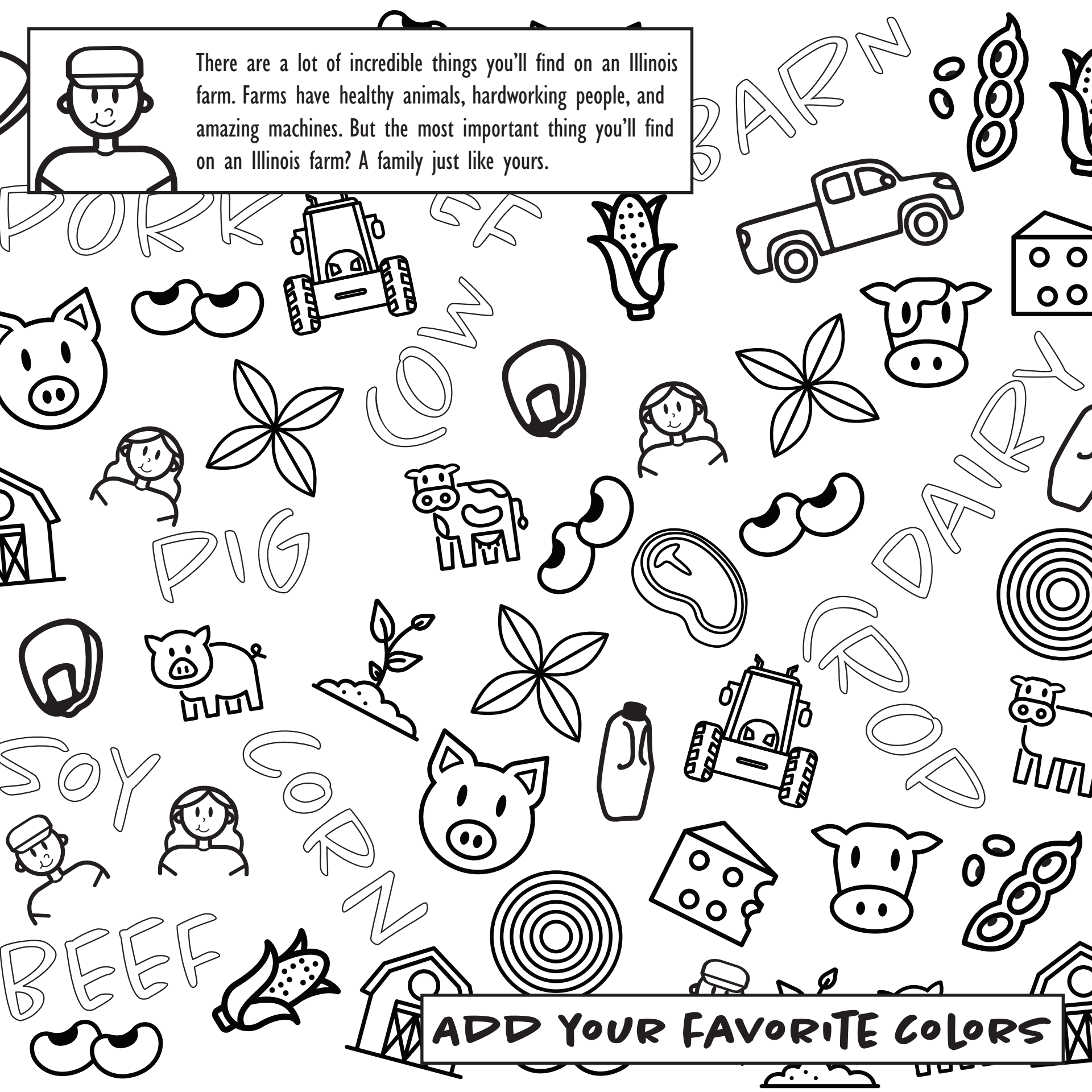

**ADD YOUR FAVORITE COLORS**

# FARM FUN WORD SEARCH

Instructions: Find all the words from the list hidden in the grid and circle each word as you find it.

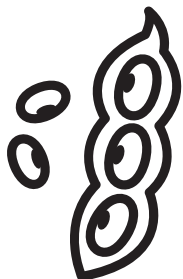
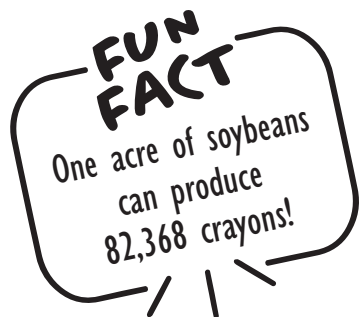

Cow  
Pig

Corn  
Soybean

Barn  
Farmer

Crop  
Tractor

Field  
Grow



Because in Illinois, almost all farming is done by families. We work together — kids, parents, grandparents, uncles, aunts, cousins — to grow good food with care.



So what is it like growing up growing? It means that you never know what each day will bring. You just know you will be tackling it together. We wouldn't trade it for anything in the world.

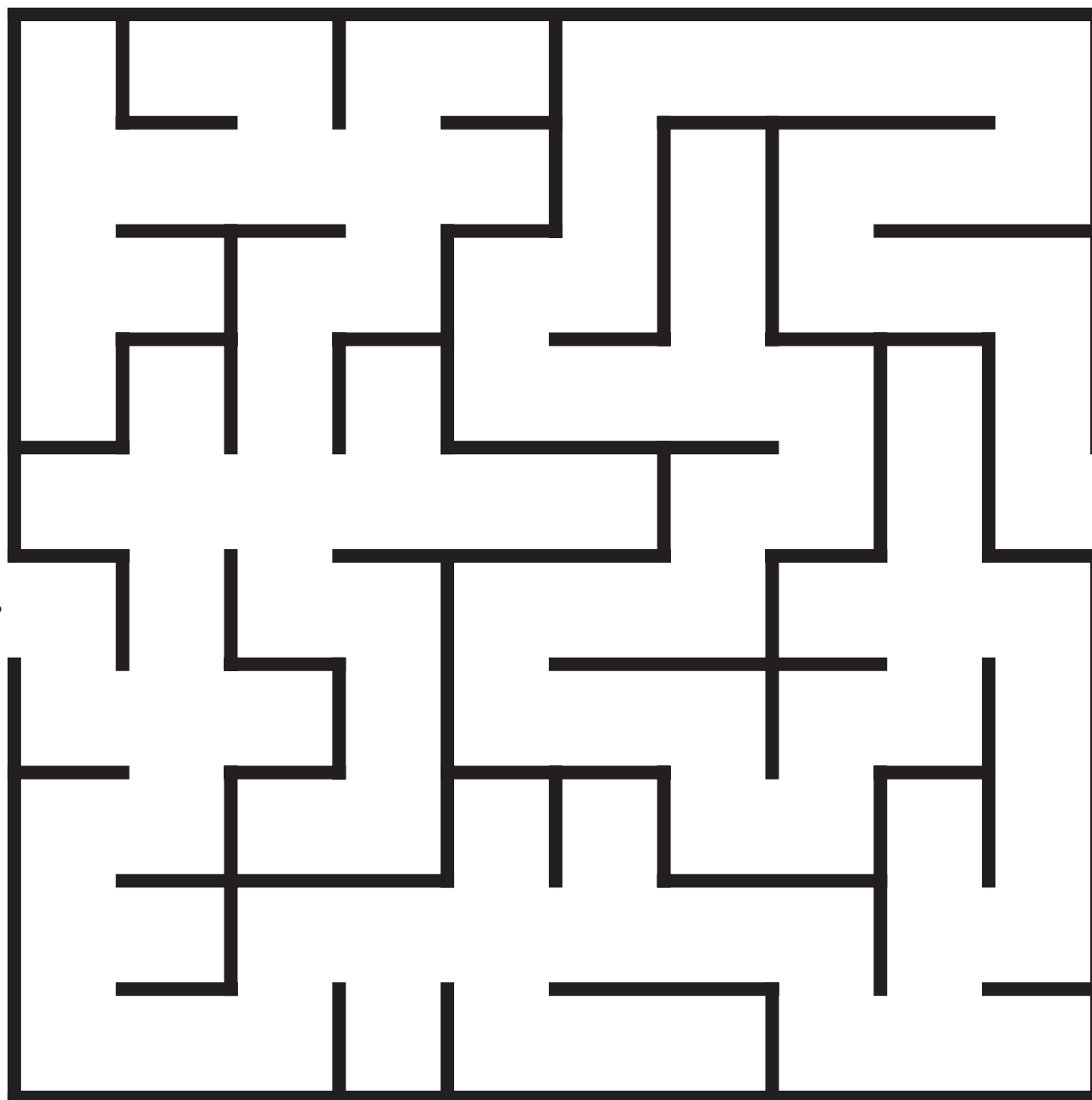

START  
HERE



END  
HERE

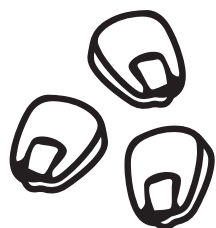

**Instructions:** Find your way through the corn maze from start to end. Follow the path and avoid dead ends!

**CORN MAZE**

# FROM OUR FARMS TO YOUR FRIDGE, SEE THE JOURNEY OF YOUR MILK.

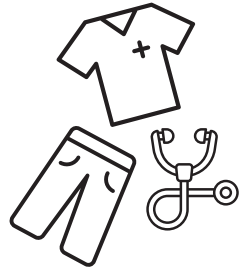

Dairy cows are well cared for with regular vet checks.

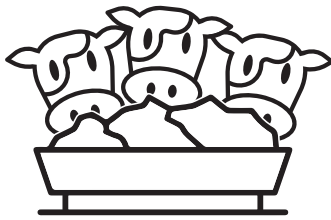

Dairy cows eat roughly 115 pounds of food per day.

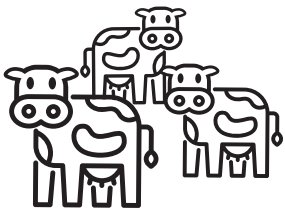

Dairy cows are milked 2-3 times per day.

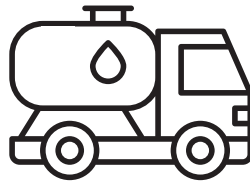

Milk is tested and taken to the plant.



Milk is pasteurized for safety and bottled.

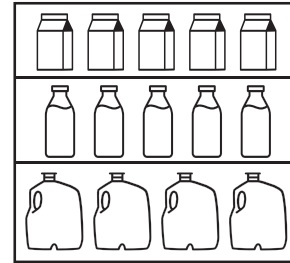

Milk arrives in grocery stores less than two days after leaving the farm.

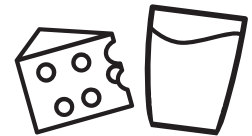

Milk and cheese are a part of a balanced diet—plus, they're delicious!



On the farm, it's all about care. We care for our animals, crops and land like we care for each other. Because we eat the same food all families eat.



To be successful, farmers need to be lifelong learners.  
It's not just kids that gain new skills every year —  
every member of the farm is always learning.

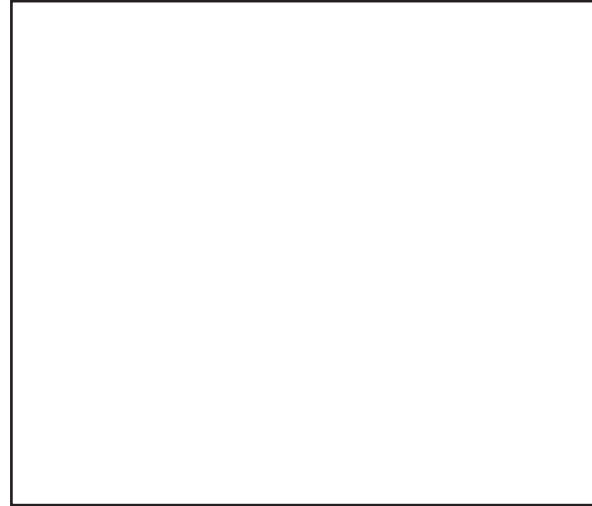
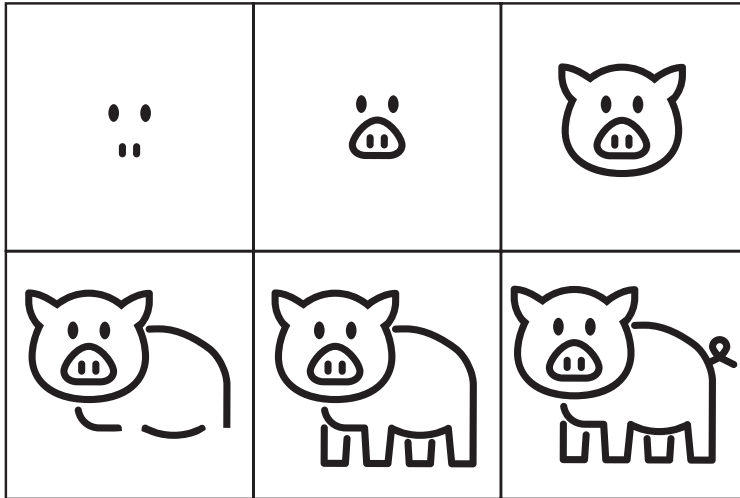

**Instructions:** Do you know how to draw a pig? Follow these steps and try for yourself.

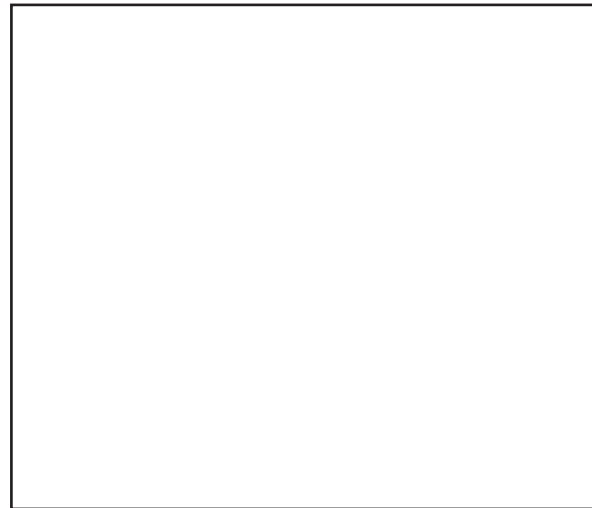
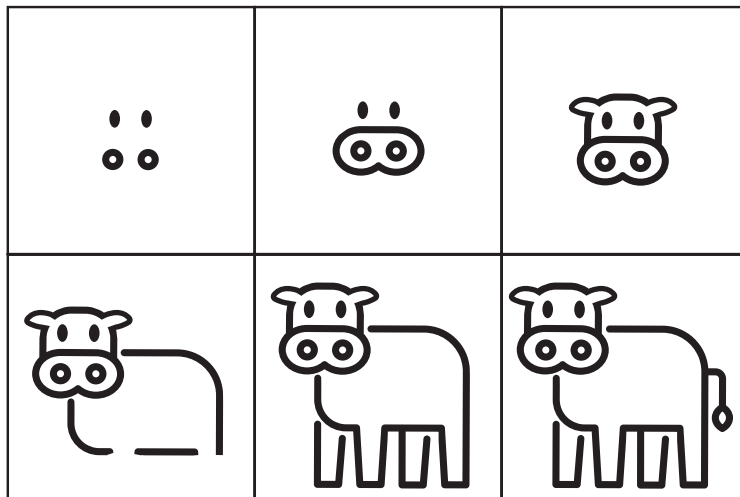

**Instructions:** Do you know how to draw a cow? Follow these steps and try for yourself.

# HOW TO DRAW ANIMALS

# HOW TO DRAW EQUIPMENT

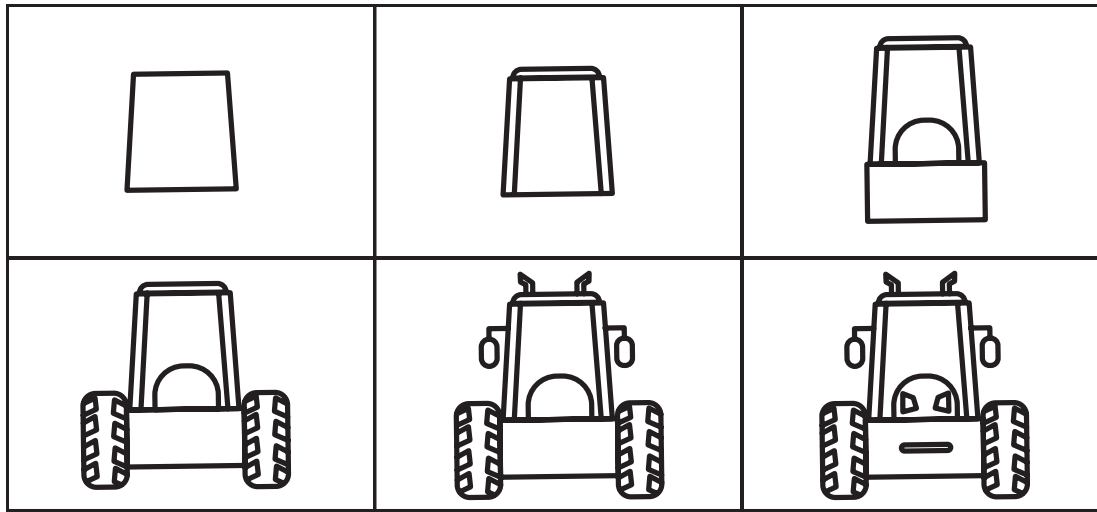

**Instructions:** Do you know how to draw a tractor? Follow these steps and try for yourself.

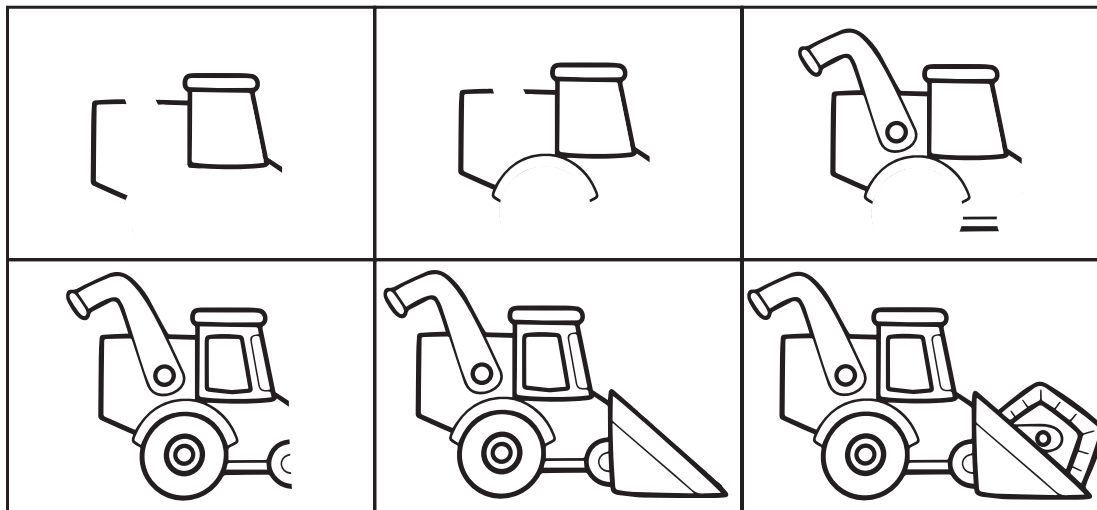
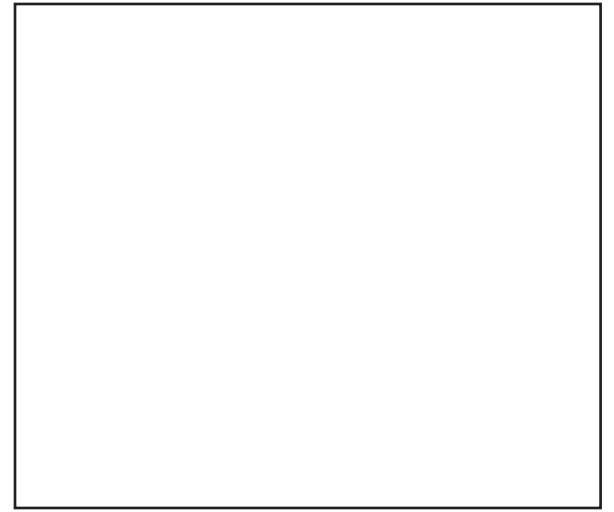

**Instructions:** Do you know how to draw a combine? Follow these steps and try for yourself.

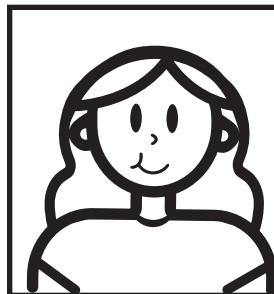
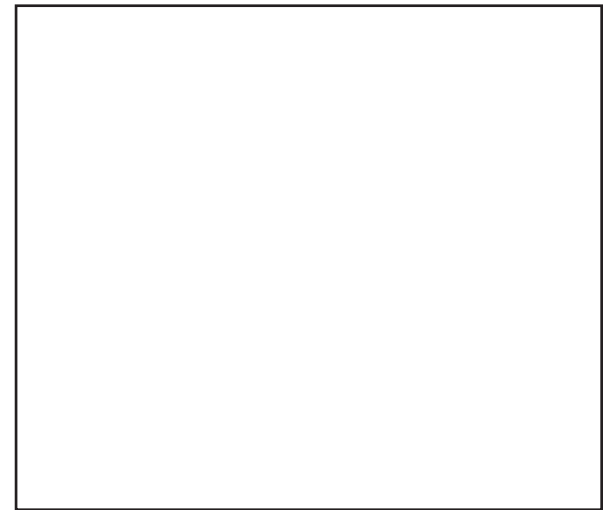

And it's lots and lots of learning-by-doing. You teach each other and you test yourself. On farms, hard work is rewarded.



For curious minds, the farm is a dream come true.  
There's always new technologies, new ideas, and new  
techniques to help the land and animals thrive.

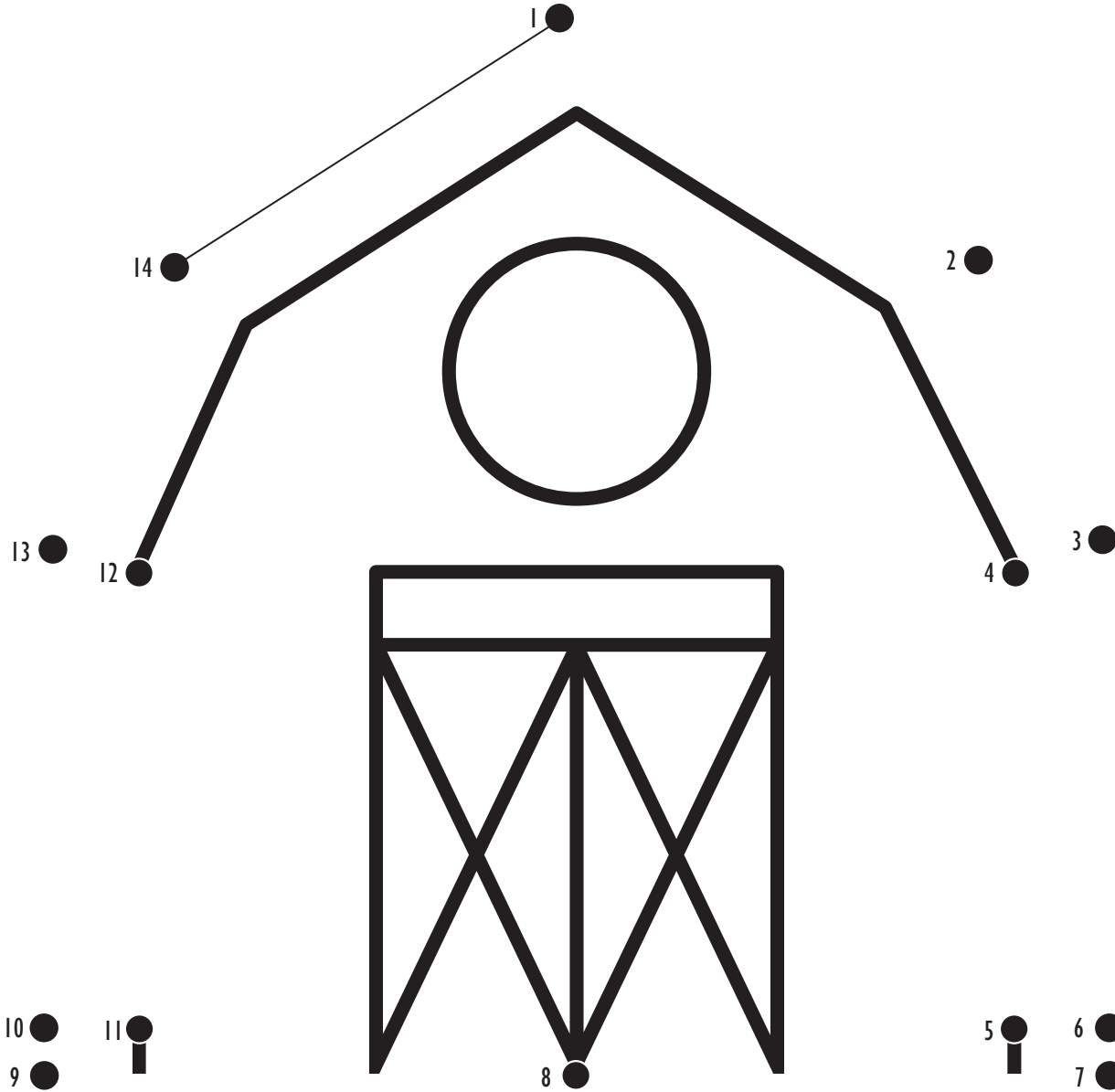

**Instructions:** Connect the dots by drawing lines from one number to the next in numerical order. Then, color it in!

**CONNECT THE DOTS**



# CROSSWORD PUZZLE

**Instructions:** Fill in the crossword puzzle by solving the clues provided. Write the answers in the corresponding numbered spaces on the grid.

## Down

1. Breakfast link
2. Dairy drink
3. Movie theater snack
4. Hamburgers are made out of this
6. Place to buy food and drinks
8. Often found on pizza

## Across

5. Breakfast strip
7. Food shopping items
9. Evening meal

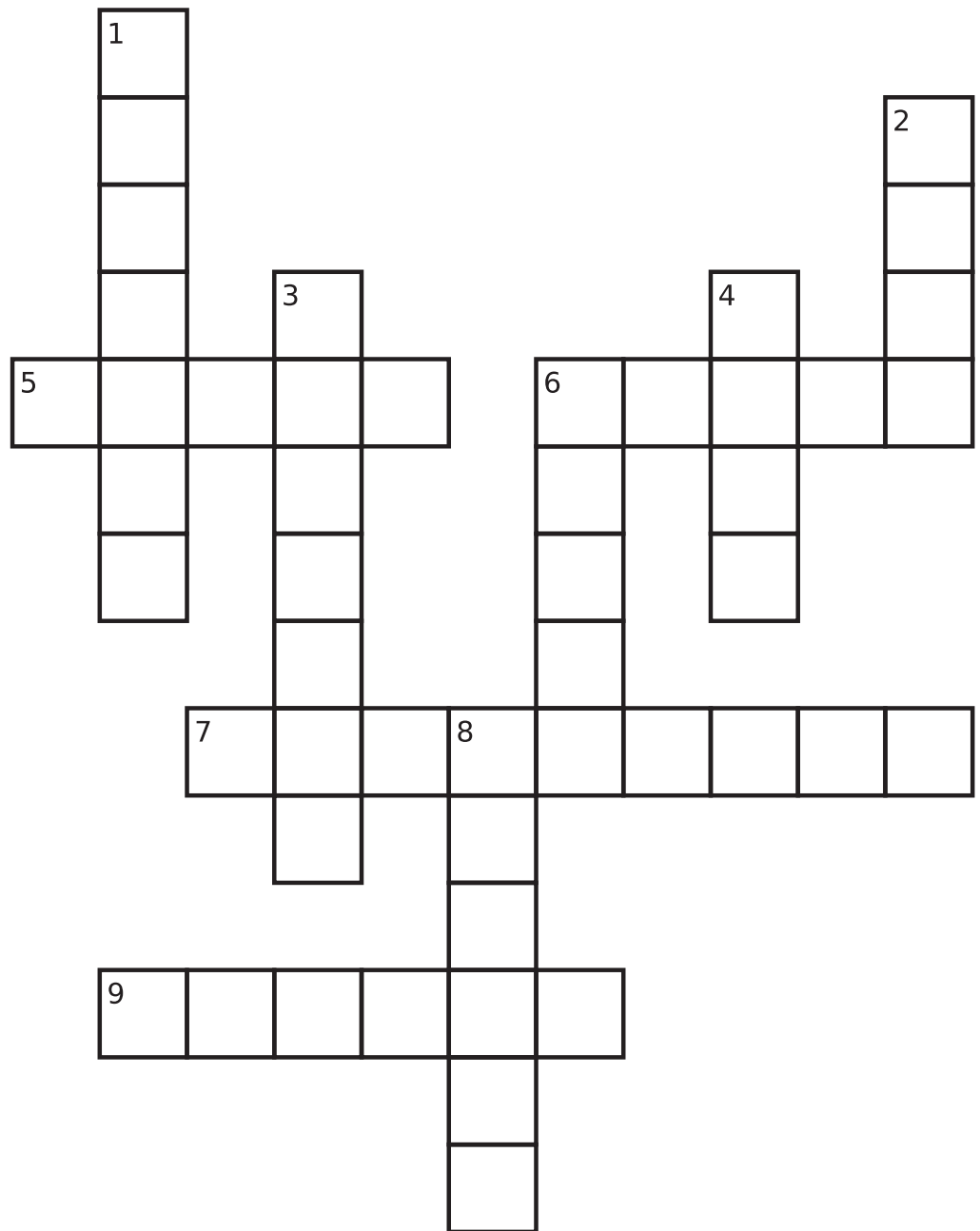

Down  
1. Sausage 2. Milk 3. Popcorn 4. Beef 6. Store 8. Cheese  
Across  
5. Bacon 6. Steak 7. Groceries 9. Dinner

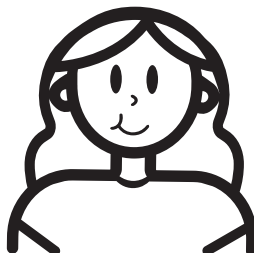

Some times are busier than others. When harvest rolls around, it's all-hands-on-deck. Working with family makes the long days worth it.

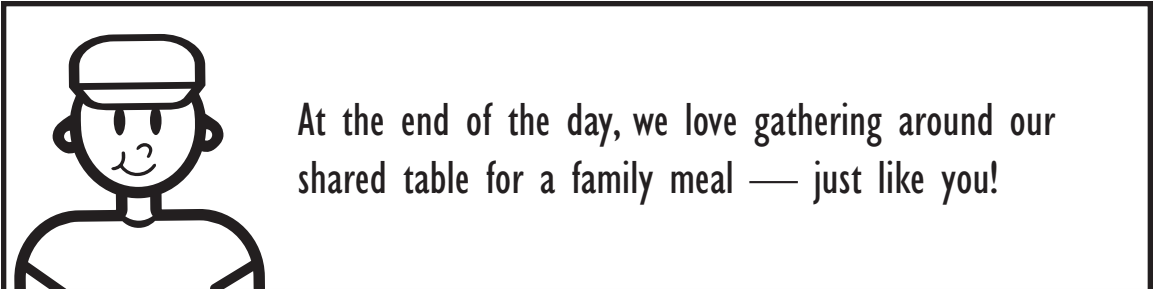

At the end of the day, we love gathering around our shared table for a family meal — just like you!

**FUN FACT**  
Did you know field corn is a grain and sweet corn is a veggie?

**Instructions:** Draw a picture of your favorite food. Use lots of colors to make it look delicious!

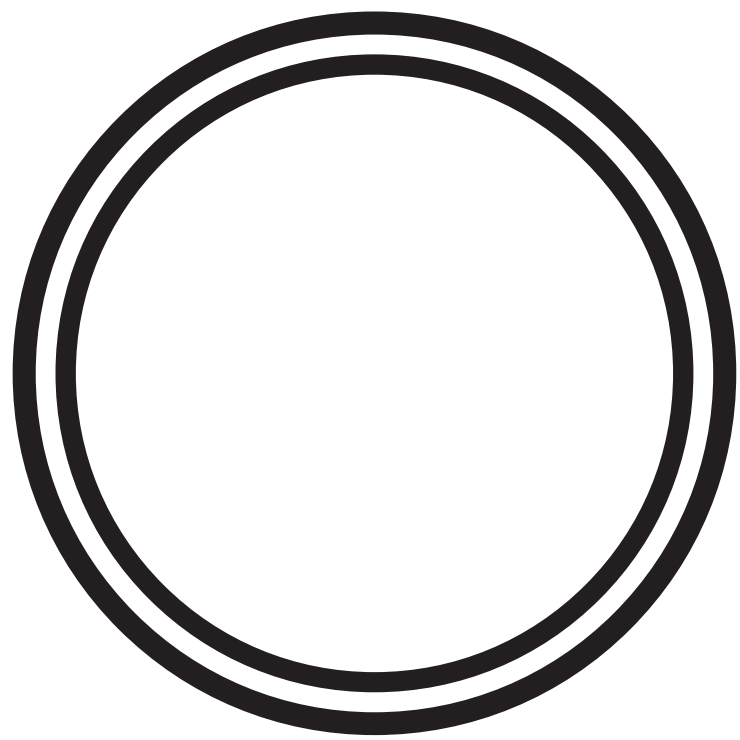
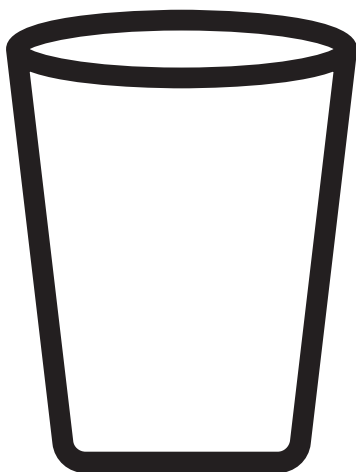

**DRAW YOUR FAVORITE FOOD**

**ILLINOIS FARMERS BRING YOU BEEF,  
PORK, CORN, SOYBEANS, DAIRY,  
AND SO MUCH MORE!**

Instructions: Color the picture using  
your favorite crayons or markers.

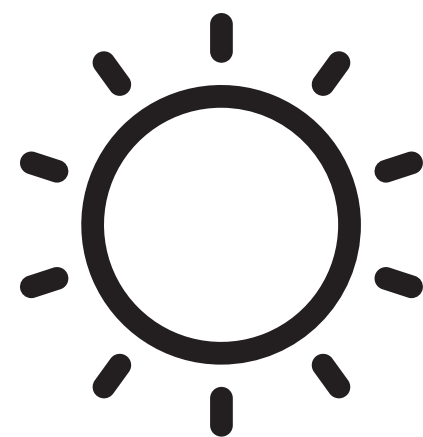

What is life really like on an Illinois family farm? It's making memories. It's learning lifelong values. It's what family is all about.



**WE ARE YOUR  
FAMILY FARMERS,  
AND WE'D LOVE TO  
HEAR FROM YOU.**